

MOULDin Oy



Interchangeability - Kompatibilität

HASCO, DYROS, EOC, PARADISI
(EURO CONNECTOR)

Temperature Range-Temperaturbereich

-20°C +100°C (-40°F +250°F) Nitrile- NBR
-20°C +200°C (-40°F +390°F) Viton- V

Working Pressure - Betriebsdruck

0 - 10 bar (0 - 145 PSI) 059
0 - 10 bar (0 - 145 PSI) 060
0 - 15 bar (0 - 220 PSI) 090
0 - 20 bar (0 - 290 PSI) 190

Flow capacity - Größen

NW - 6 (060)
NW - 9 (090)
NW - 13 (190)

Standard version - Standardversion

Brass Messing
Viton Seal - Viton Dichtung

Options - Optionen

K - Verchromt - Chrome plated
N - Vernickelt - Nickel plated
S - Stählen - Steel

Fügen Sie den gewünschten

Optionsbuchstaben für Nicht-Standardaufträge
an das Ende des Bestellcodes hinzu.
For optional orders please add the symbol
of your option end of the order number
(090 EG 14 K-N)

Material - Material

Coupler Body-
Kupplungsgrundkörper : Brass - Messing
Sleeve - Hülse : Brass - Messing
Valve - Ventil : Brass - Messing
Springs - Federn : Stainless Steel -
Edelstahl

Locking O-Ring-
Sprengling : Stainless Steel -
Edelstahl

Balls - Kugeln : Stainless Steel -
Edelstahl

Seals - Dichtungen : Viton (V)
Plug - Nippel : Brass - Messing

Using Area :

- On cooling system of plastic zamak, brass and aluminium injection molds
- On cleaning and washing systems of machines
- On hot oil lines connection
- All industries
- On steam line

Nutzungsbereich:

- an Kühlsystemen für Kunststoff-, Zinkdruckguss-, Messing- und Aluminium-Kokillenformen
- Reinigungs und Waschsyste-men von Maschinen
- Heissölleitungsanschlüssen
- Alle Industriezweige
- Dampfleitungen



With Valve - Mit Ventil
Order No - Bestell Nr.

Without Valve - Ohne Ventil
Order No - Bestell Nr.

NW d1 d2 d3 d4 L L1

CSK T060 - 06	SK T060 - 06	6	6 - 1/4"	4.5	17	9	46	17
CSK T060 - 08	SK T060 - 08	6	8 - 5/16"	6	17	9	46	17
CSK T060 - 09	SK T060 - 09	6	9 - 5/14"	6	17	9	46	17
CSK T060 - 10	SK T060 - 10	6	10 - 3/8"	6	17	9	46	17
CSK T060 - 13	SK T060 - 13	6	13 - 1/2"	6	17	9	52	23
CSK T090 - 10	SK T090 - 10	9	10 - 3/8"	8	23	13	60	23
CSK T090 - 13	SK T090 - 13	9	13 - 1/2"	10	23	13	60	23
CSK T190 - 19	SK T190 - 19	13	19 - 3/4"	13	31	19	90	32
CSK T190 - 25	SK T190 - 25	13	19 - 1"	20	31	19	90	32

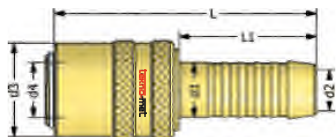

Standard hose tail socket
Kupplung mit gerader Standard-Schlauchtülle



With Valve - Mit Ventil
Order No - Bestell Nr.

Without Valve - Ohne Ventil
Order No - Bestell Nr.

NW d1 d2 d3 d4 L L1

CSK T060 - 06 - 45°	SK T060 - 06 - 45°	6	6 - 1/4"	4.5	17	9	41	17
CSK T060 - 08 - 45°	SK T060 - 08 - 45°	6	8 - 5/16"	6	17	9	41	17
CSK T060 - 09 - 45°	SK T060 - 09 - 45°	6	9 - 5/14"	6	17	9	41	17
CSK T060 - 10 - 45°	SK T060 - 10 - 45°	6	10 - 3/8"	6	17	9	41	17
CSK T060 - 13 - 90°	SK T060 - 13 - 90°	6	13 - 1/2"	9	17	9	41	17
CSK T090 - 10 - 45°	SK T090 - 10 - 45°	9	10 - 3/8"	8	23	13	51	23
CSK T090 - 13 - 45°	SK T090 - 13 - 45°	9	13 - 1/2"	9	23	13	51	23
CSK T190 - 19 - 45°	SK T190 - 19 - 45°	13	19 - 3/4"	13	31	19	78	32
CSK T190 - 25 - 45°	SK T190 - 25 - 45°	13	19 - 1"	20	31	19	90	32

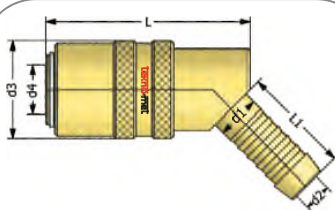

Standard hose tail socket 45°
Kupplung mit 45° Standard-Schlauchtülle

T060-T090-T190 Series

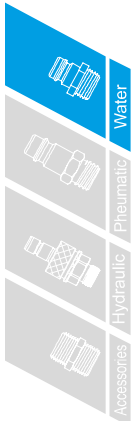

Wenn Sie Kupplungen
Mit Sicherheit bestellen
Bitte am ende der
bestell-NR OCB hinzufügen
Beispiel: CSK09-13 OCB

If you order couplings with
safety please add OCB at
the end of the order number
Example: CSK09-13 OCB

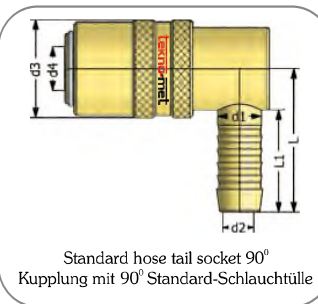

Standard hose tail socket 90°
Kupplung mit 90° Standard-Schlauchtülle

With Valve - Mit Ventil Order No - Bestell Nr.	Without Valve - Ohne Ventil Order No - Bestell Nr.	NW	d1	d2	d3	d4	L	L1
CSK T060 - 06 - 90°	SKT 060 - 06 - 90°	6	6 - 1/4"	4.5	17	9	41	17
CSK T060 - 08 - 90°	SK T060 - 08 - 90°	6	8 - 5/16"	6	17	9	41	17
CSK T060 - 09 - 90°	SKT 060 - 09 - 90°	6	9 - 5/14"	6	17	9	41	17
CSK T060 - 10 - 90°	SKT 060 - 10 - 90°	6	10 - 3/8"	6	17	9	41	17
CSK T060 - 13 - 90°	SKT 060 - 13 - 90°	6	13 - 1/2"	9	17	13	41	17
CSK T090 - 10 - 90°	SKT 090 - 10 - 90°	9	10 - 3/8"	8	23	13	51	23
CSK T090 - 13 - 90°	SKT 090 - 13 - 90°	9	13 - 1/2"	9	23	13	51	23
CSK T190 - 19 - 90°	SKT 190 - 19 - 90°	13	19 - 3/4"	13	31	19	78	32
CSK T190 - 25 - 90°	SKT 190 - 25 - 90°	13	25 - 1"	20	31	19	78	32

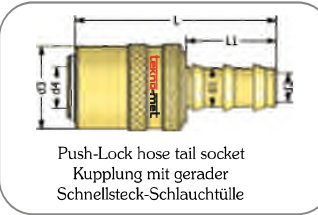

Push-Lock hose tail socket
Kupplung mit gerader
Schnellsteck-Schlauchtülle

With Valve - Mit Ventil Order No - Bestell Nr.	Without Valve - Ohne Ventil Order No - Bestell Nr.	NW	d1	d2	d3	d4	L	L1
CSK T060 - FG06	SKT060 - FG06	6	6 - 1/4"	5	17	9	52	24
CSK T060 - FG10	SKT060 - FG10	6	10 - 3/8"	7	17	9	52	24
CSK T060 - FG13	SKT060 - FG13	6	13 - 1/2"	13	17	9	52	24
CSK T090 - FG10	SKT090 - FG10	9	10 - 3/8"	8	23	13	64	28
CSK T090 - FG13	SKT090 - FG13	9	13 - 1/2"	10	23	13	64	28
CSK T190 - FG19	SKT190 - FG19	13	19 - 3/4"	13	31	19	96	38
CSK T190 - FG25	SKT190 - FG25	13	25 - 1"	20	31	19	98	38

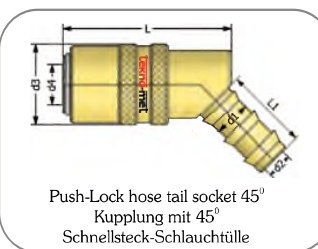

Push-Lock hose tail socket 45°
Kupplung mit 45°
Schnellsteck-Schlauchtülle

With Valve - Mit Ventil Order No - Bestell Nr.	Without Valve - Ohne Ventil Order No - Bestell Nr.	NW	d1	d2	d3	d4	L	L1
CSK T060 - FG06 - 45°	SKT060 - FG06 - 45°	6	6 - 1/4"	5	17	9	48	24
CSK T060 - FG10 - 45°	SKT060 - FG10 - 45°	6	10 - 3/8"	7	17	9	48	24
CSK T060 - FG13 - 45°	SKT060 - FG13 - 45°	6	13 - 1/2"	10	17	9	48	24
CSK T090 - FG10 - 45°	SKT090 - FG10 - 45°	9	10 - 3/8"	8	23	13	55	28
CSK T090 - FG13 - 45°	SKT090 - FG13 - 45°	9	13 - 1/2"	10	23	13	55	28
CSK T190 - FG19 - 45°	SKT190 - FG19 - 45°	13	19 - 3/4"	13	31	19	84	38

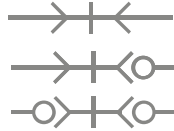

With Valve - Mit Ventil
Order No - Bestell Nr.

Without Valve - Ohne Ventil
Order No - Bestell Nr.

NW

d1

d2

d3

d4

L

L1

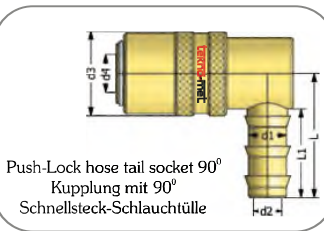

Push-Lock hose tail socket 90°
Kupplung mit 90°
Schnellsteck-Schlauchtülle

CSKT060 - FG06 - 90°	SKT060 - FG06 - 90°	6	6 - 1/4"	5	17	9	48	24
CSKT060 - FG10 - 90°	SKT060 - FG10 - 90°	6	10 - 3/8"	7	17	9	47	24
CSKT060 - FG13 - 90°	SKT060 - FG13 - 90°	6	13 - 1/1"	10	17	13	47	24
CSKT090 - FG10 - 90°	SKT090 - FG10 - 90°	9	10 - 3/8"	8	23	13	55	28
CSKT090 - FG13 - 90°	SKT090 - FG13 - 90°	9	13 - 1/2"	10	23	13	55	28
CSKT190 - FG19 - 90°	SKT190 - FG19 - 90°	13	19 - 3/4"	13	31	19	84	38
CSKT190 - FG25 - 90°	SKT190 - FG25 - 90°	13	25 - 1"	20	31	19	86	38



With Valve - Mit Ventil
Order No - Bestell Nr.

Without Valve - Ohne Ventil
Order No - Bestell Nr.

NW

d2

d3

d4

L

L1

SW

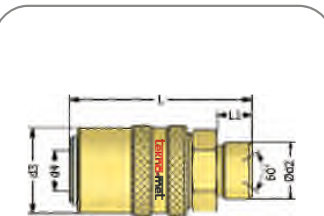

Cylindrical Male Thread socket
Kupplung mit Aussengewinde zylindrisch

CSK T060 - EG10	SK T060 - EG10	6	M10x1	17	9	48	9	17
CSK T060 - EG13	SK T060 - EG13	6	G 1/4"	17	9	48	9	17
CSK T060 - EG14	SK T060 - EG14	6	M14x1.5	17	9	48	9	17
CSK T060 - EG17	SK T060 - EG17	6	G 3/8"	17	9	48	9	17
CSK T090 - EG13	SK T090 - EG13	9	G1/4"	23	9	52	9	17
CSK T090 - EG16	SK T090 - EG16	9	M16x1.5	23	9	52	9	21
CSK T090 - EG17	SK T090 - EG17	9	G 3/8"	23	13	52	9	21
CSK T090 - EG21	SK T090 - EG21	9	G 1/2"	23	13	52	12	22
CSK T190 - EG21	SK T190 - EG21	13	G 1/2"	31	19	74	12	30
CSK T190 - EG24	SK T190 - EG24	13	M24x1.5	31	19	78	16	30



With Valve - Mit Ventil
Order No - Bestell Nr.

Without Valve - Ohne Ventil
Order No - Bestell Nr.

NW

d2

d3

d4

L

L1

SW

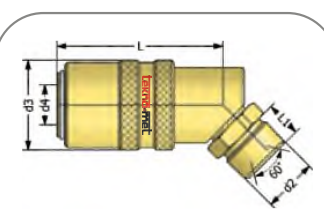

Cylindrical Male Thread socket 45°
Kupplung mit 45° Aussengewinde zylindrisch

CSKT060 - EG13 - 45°	SKT060 - EG13 - 45°	6	G 1/4"	17	9	48	9	17
CSKT060 - EG14 - 45°	SKT060 - EG14 - 45°	6	M14x1.5	17	9	48	9	17
CSKT060 - EG17 - 45°	SKT060 - EG17 - 45°	6	G 3/8"	17	9	48	9	17
CSKT090 - EG17 - 45°	SKT090 - EG17 - 45°	9	G 3/8"	23	13	55	12	21
CSKT090 - EG21 - 45°	SKT090 - EG21 - 45°	9	G 1/2"	23	13	55	12	21
CSKT190 - EG21 - 45°	SKT190 - EG21 - 45°	13	G 1/2"	31	19	76	14	30
CSKT190 - EG24 - 45°	SKT190 - EG24 - 45°	13	M24x1.5	31	19	78	16	30

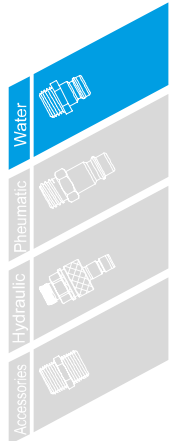

T060-T090-T190 Series

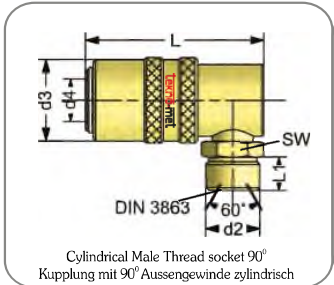
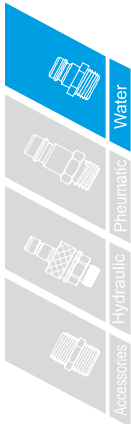

With Valve - Mit Ventil Order No - Bestell Nr.	Without Valve - Ohne Ventil Order No - Bestell Nr.	NW	d2	d3	d4	L	L1	SW
CSKT060 - EG13 -90°	SKT060 - EG13 -90°	6	G 1/4"	17	9	48	11	17
CSKT060 - EG14 -90°	SKT060 - EG14 -90°	6	M14x1.5	17	9	48	11	17
CSKT060 - EG17 -90°	SKT060 - EG17 -90°	6	G 3/8"	17	9	48	11	17
CSKT090 - EG17 -90°	SKT090 - EG17 -90°	9	G 3/8"	23	13	52	11	21
CSKT090 - EG21 -90°	SKT090 - EG21 -90°	9	G 1/2"	23	13	52	11	21
CSKT190 - EG21 -90°	SKT190 - EG21 -90°	13	G 1/2"	31	19	76	14	30
CSKT190 - EG24 -90°	SKT190 - EG24 -90°	13	M24x1.5	31	19	78	16	30

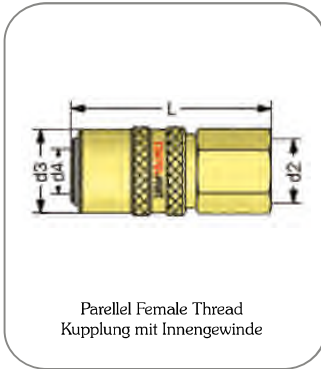

With Valve - Mit Ventil Order No - Bestell Nr.	Without Valve - Ohne Ventil Order No - Bestell Nr.	NW	d2	d3	d4	L	L1	SW
CSKT060 - DG10	SKT060 - DG10	6	10x1	17	9	44	9	17
CSKT060 - DG13	SKT060 - DG13	6	G 1/4"	17	9	44	11	17
CSKT060 - DG14	SKT060 - DG14	6	M14x1.5	17	9	44	11	17
CSKT060 - DG17	SKT060 - DG17	6	G 3/8"	17	9	44	11	17
CSKT090 - DG13	SKT090 - DG13	9	G 1/4"	23	13	48	11	17
CSKT090 - DG16	SKT090 - DG16	9	M16x1.5	23	13	48	11	21
CSKT090 - DG17	SKT090 - DG17	9	G 3/8"	23	13	48	11	21
CSKT090 - DG21	SKT090 - DG21	9	G 1/2"	23	13	48	11	21
CSKT190 - DG21	SKT190 - DG21	13	G 1/2"	31	19	70	14	30
CSKT190 - DG24	SKT190 - DG24	13	M24x1.5	31	19	72	16	30
CSKT190 - DG26	SKT190 - DG26	13	G 3/4"	31	19	72	16	30

Safety Type Coupler for disconnected protection Sicherheitsfunktion für das ungewollte Trennen

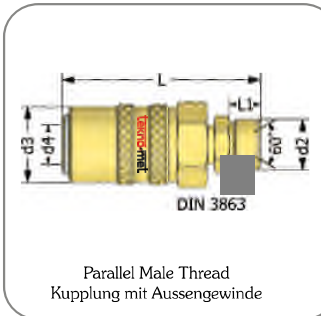

With Valve - Mit Ventil Order No - Bestell Nr.	Without Valve - Ohne Ventil Order No - Bestell Nr.	NW	d2	d3	d4	L	L1	SW
CSK T060 - EG10/EM	SK T060 - EG10/EM	6	M10x1	17	9	52	9	17
CSK T060 - EG13/EM	SK T060 - EG13/EM	6	G 1/4"	17	9	52	9	17
CSK T060 - EG14/EM	SK T060 - EG14/EM	6	M14x1.5	17	9	52	9	17
CSK T060 - EG17/EM	SK T060 - EG17/EM	6	G 3/8"	17	9	52	9	17
CSK T090 - EG13/EM	SK T090 - EG13/EM	9	G 1/4"	23	9	60	9	22
CSK T090 - EG16/EM	SK T090 - EG16/EM	9	M16x1.5	23	9	60	9	22
CSK T090 - EG17/EM	SK T090 - EG17/EM	9	G 3/8"	23	13	60	9	22
CSK T090 - EG21/EM	SK T090 - EG21/EM	9	G 1/2"	23	13	62	9	22
CSK T190 - EG21/EM	SK T190 - EG21/EM	13	G 1/2"	31	19	89	12	32
CSK T190 - EG24/EM	SK T190 - EG24/EM	13	M24x1.5	31	19	90	16	32



Short Type

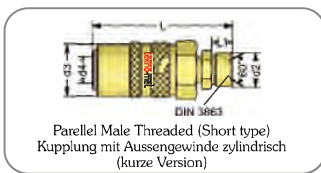

With Valve - Mit Ventil Order No - Bestell Nr.	NW	d2	d3	d4	L	L1	SW
TCSK060 - EG13/KB	6	G 1/4"	18	9	38	9	17
TCSK090 - EG17/KB	9	G 3/8"	23	13	38	9	17

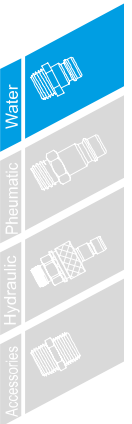

Blind Socket / Blindkupplung

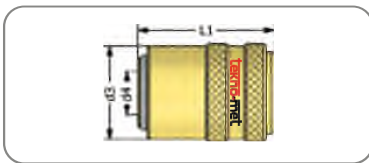

Order No - Bestell Nr.	NW	d3	d4	L1
------------------------	----	----	----	----

T060 KTG 00	6	17	9	36
T090 KTG 00	9	23	13	36

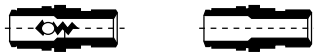

Adapting Socket With T6-T9 Plugs Adapterkupplung mit T6-T9 Nippel

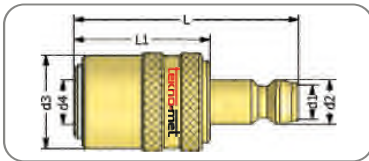

With Valve - Mit Ventil Order No - Bestell Nr.	Without Valve - Ohne Ventil Order No - Bestell Nr.	NW	d2	d1	d3	d4	L	L1
---	---	----	----	----	----	----	---	----

CSKT060 AU 090	SKT060 AU 090	6	6	9	18	9	45	44
CSKT090 AU 060	SKT090 AU 060	9	9	13	23	13	50.5	45



Adapting Socket with T060-T090 Plugs Adapterkupplung mit T060-T090 Nippel

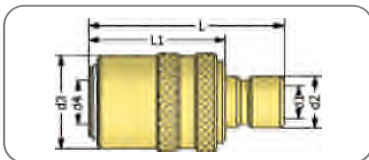

With Valve - Mit Ventil Order No - Bestell Nr.	Without Valve - Ohne Ventil Order No - Bestell Nr.	NW	d1	d2	d3	d4	L	L1
---	---	----	----	----	----	----	---	----

CSKT060 AU 06	SKT060 AU 06	6	6	9	18	9	56	44
CSKT090 AU 09	SKT090 AU 09	9	9	13	23	13	60	45

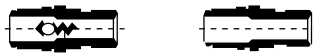

Adapting Socket with T100.08 Plug Adapterkupplung mit Buchse

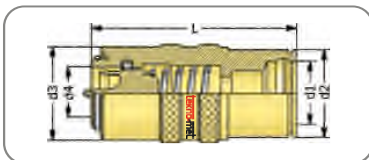

With Valve - Mit Ventil Order No - Bestell Nr.	Without Valve - Ohne Ventil Order No - Bestell Nr.	NW	d1	d2	d3	d4	L
---	---	----	----	----	----	----	---

SKT060 AU 100.08	CSKT060 AU 100.08	6	17	21	18	9	56
SKT090 AU 100.08	CSKT090 AU 100.08	9	17	21	23	13	60

Adapting Plug T060 - T090 Adaptornippel T060-T090

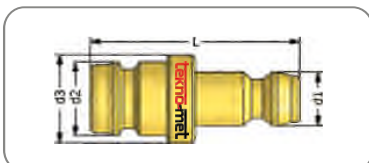

Order No - Bestell Nr.	d1	d2	d3	L
------------------------	----	----	----	---

T060 HEF T090	9	13	14	32
T090 HEF T090	13	13	14	31
T090 HEF T09	13	13	13	35
T060 HEF T060	9	9	10	30
T060 HEF T06	9	9	10	29

T060-T090-T190 Series



Plugs- Nippel

Stop Plug - Blindnippel



Order No - Bestell Nr. d1

T060 KTU 00	9
T060 KTU 00	13
T060 KTU 00	19

Sichere Kopplung -
Safety type coupler
for disconnect protection

Fügen Sie den Code "S"
der Reihe nach hinzu.
Add "S" to item code

Diverting Socket Umlenk Kupplungen

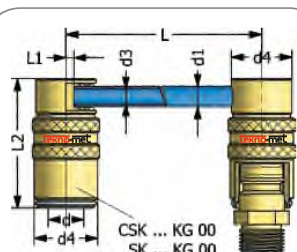

"Not released for sale in Germany"

With Valve - Mit Ventil Order No - Bestell Nr.	Without Valve - Ohne Ventil Order No - Bestell Nr.	d	d1	d2	d3	d4	t	h	L	L1	L2
CSKT60 - KG 125	SKT060 - KG 125	9	8	20	6	17	18	29	125	0	44
CSKT060 - KG 250	SKT060 - KG 250	9	8	20	6	17	18	29	250	0	44
CSKT060 - KG 500	SKT060 - KG 500	9	8	20	6	17	18	29	500	0	44
CSKT090 - KG 125	SKT090 - KG 125	13	10	26	8	23	18	39	125	2	53
CSKT090 - KG 250	SKT090 - KG 250	13	10	26	8	23	18	39	250	2	53
CSKT090 - KG 500	SKT090 - KG 500	13	10	26	8	23	18	39	500	2	53
CSKT190 - KG 160	SKT190 - KG 160	19	14	36	12	31	36	54	160	3	80
CSKT190 - KG 315	SKT190 - KG 315	19	14	36	12	31	36	54	315	3	80
CSKT190 - KG 500	SKT190 - KG 500	19	14	36	12	31	36	54	500	3	80

Push-Lock Hose Plug Stecknippel mit Schnellsteck-Achslachttülle

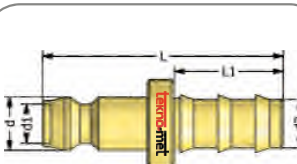

Order No - Bestell Nr.	d	d1	d2	L mm	L1 mm
T060 FU 10	9	6	10 - 3/8"	41	24
T060 FU 13	9	6	13 - 1/2"	45	24
T090 FU 10	13	9	10 - 3/8"	41	24
T090 FU 13	13	9	13 - 1/2"	45	28
T190 FU 13	19	13	13 - 1/2"	60	28
T190 FU 19	19	13	19 - 3/4"	70	38

Standard Hose barbs Standard Schlauchtülle

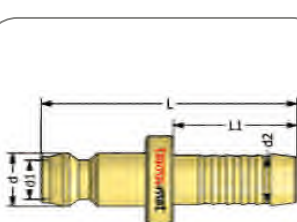

Order No - Bestell Nr.	d (mm)	d1	d2	L	L1
T060 - HU 06	9	6	6 - 1/4"	37	17
T060 - HU 08	9	6	8 - 5/16"	37	17
T060 - HU 09	9	6	9 - 5/14"	37	17
T060 - HU 10	9	6	10 - 3/8"	37	17
T060 - HU 13	9	6	13 - 1/2"	37	17
T090 - HU 10	13	9	10 - 3/8"	39	23
T090 - HU 13	13	9	13 - 1/2"	39	23
T190 - HU 13	19	13	13 - 1/2"	53	23
T190 - HU 19	19	13	19 - 3/4"	62	27

T060-T090-T190 Series

Plugs- Nippel



Plug with thread (T090 serie) Nippel mit Gewinde (T090 serie)



Order No - Bestell Nr.	Ød	Ød1	L	SW
T090 DU 13	BSP 1/4"	13	26	17
T090 DU 17	BSP 3/8"	13	26	19
T090 DU 21	BSP 1/2"	13	28	24

Plug with thread (T190 serie) Nippel mit Gewinde (T190 serie)

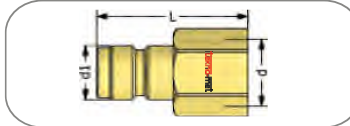

Order No - Bestell Nr.	Ød	Ød1	L	SW
T190 DU 21	BSP 1/2"	19	46	24
T190 DU 26	BSP 3/4"	19	50	30

Inner hex.Plugs for T090 Serie Nippel mit Gewinde (T090 serie)

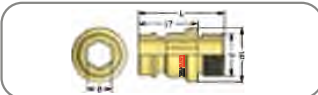

Order No - Bestell Nr.	d	d1	L
T090 AUM 14	M14x1.5	14.5	26
T090 AUG 13	G 1/4"	13.5	26
T090 AUG 17	G 3/8"	17	26

Plug with valve (T060 serie) Verschlussnippel (T060)

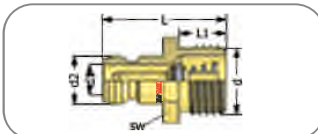

Order No - Bestell Nr.	d	d1	d2	L	L1	SW
T060 - EN 13 V	G 1/4"	6	9	30	12	14
T060 - ENM 14 V	M14x1.5	6	9	30	12	14
T060 - EN 17 V	G 3/8"	6	9	30	12	17

Plug with valve (T090 serie) Verschlussnippel (T090)

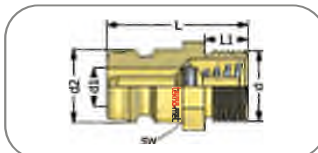

Order No - Bestell Nr.	d	d1	d2	L	L1	SW
T090 - EN 13 V	G 1/4"	9	13	30	12	14
T090 - ENM 14 V	M14x1.5	9	13	30	12	14
T090 - ENM 16 V	M16x1.5	9	13	30	12	17
T090 - EN 17 V	G 3/8"	9	13	30	12	17
T090 - EN 21 V	G 1/2"	9	13	30	12	21

Plug with valve (T190 serie) Verschlussnippel (T190)

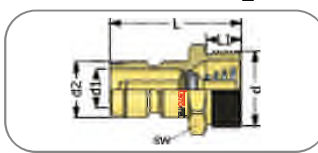

Order No - Bestell Nr.	d	d1	d2	L	L1	SW
T190 - EN 21 V	G 1/2"	13	19	51	16	22
T190 - ENM 24 V	M24x1.5	13	19	51	16	27
T190 - EN 26 V	G 3/4"	13	19	51	16	27

Angle Plug with 90° Winkelnippel mit 90°

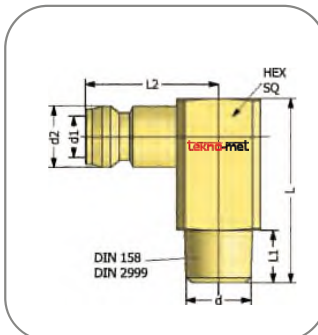

Order No - Bestell Nr.	d	d1	d2	L	L1	L2	SW(SQ)
T060 ENM 8 - 90°	M8x0.75	4.5	9	27	9	23	11
T060 ENM 10 - 90°	M10x1	6	9	27	9	23	11
T060 EN 10 - 90°	R 1/8"	6	9	27	9	23	11
T060 EN 13 - 90°	R 1/4"	6	9	34	12	23	15
T060 ENM 14 - 90°	M14x1.5	6	9	34	12	23	15
T060 EN 17 - 90°	R 3/8"	6	9	34	12	23	17
T090 EN 13 - 90°	R 1/4"	9	13	34	12	25	15
T090 ENM 14 - 90°	M14x1.5	9	13	34	12	25	15
T090 EN 17 - 90°	R 3/8"	9	13	34	12	25	17
T190 EN 21 - 90°	R 1/2"	13	19	47	16	35	24
T190 ENM 24 - 90°	M24x1.5	13	19	47	16	35	24

Plugs- Nippel



Plug & Extension plug with thread (T060 serie)
Nippel mit Gewinde (T060 serie)

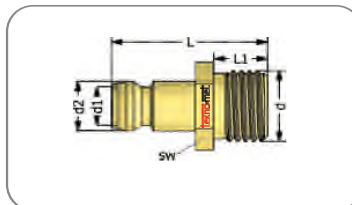

Order No - Bestell Nr.	d	d1	d2	L	L1	SW
T060 - ENM 8	M8x0.75	5	9	24	7	11
T060 - ENM 10	M10x1	6	9	24	7	11
T060 - EN 10-1.5	M10x1.5	6	9	26	9	11
T060 - EN 10	G 1/8"	6	9	24	7	11
T060 - EN 13	G 1/4"	6	9	26	9	14
T060 - ENM 14	M14x1.5	6	9	26	9	14
T060 - EN 17	G 3/8"	6	9	26	9	17

Plug & Extension plug with thread (T090 serie)
Nippel mit Gewinde (T090 serie)

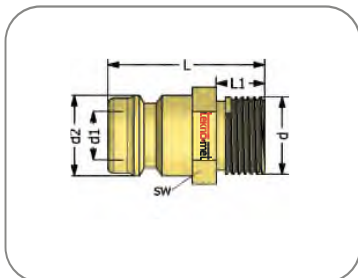

Order No - Bestell Nr.	d	d1	d2	L	L1	SW
T090 - EN 10	G 1/8"	9	13	24	7	14
T090 - ENM 10	M10x1	9	13	26	9	14
T090 - ENM 10x1.5	M10x1.5	9	13	26	9	14
T090 - ENM 12	M12x1.5	9	13	26	9	14
T090 - EN 13	G 1/4"	9	13	26	9	14
T090 - ENM 14	M14x1.5	9	13	26	9	14
T090 - ENM 16	M16x1.5	9	13	26	9	17
T090 - EN 17	G 3/8"	9	13	26	9	17
T090 - EN 21	G 1/2"	9	13	30	12	21

Plug with thread (T190 serie)
Nippel mit Gewinde (T190 serie)

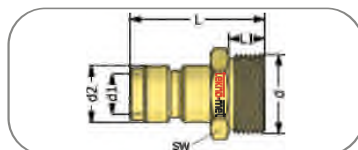

Order No - Bestell Nr.	d	d1	d2	L	L1	SW
T190 - EN 21	G 1/2"	13	19	47	12	22
T190 - ENM 24	M24x1.5	13	19	51	16	27
T190 - EN 26	G 3/4"	13	19	51	16	27

Inner hex. Plugs for T060 Serie
Nippel mit Innenschkant
Brass - Messing

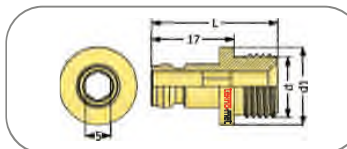

Order No - Bestell Nr.	d	d1	L
T060 AUM 08	M8x0.75	10	24
T060 AUM 10	M10x1	11	24
T060 AUG 10	G 1/8"	11	24
T060 AUG 13	G 1/4"	13.5	27

Plug with thread (T060 serie)
Nippel mit Gewinde (T060 serie)

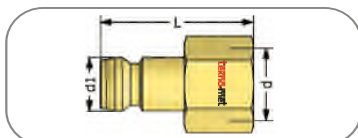

Order No - Bestell Nr.	Ød	Ød1	L	SW
T060 DU 10	BSP 1/8"	9	25	14
T060 DU 13	BSP 1/4"	9	27	17
T060 DU 17	BSP 3/8"	9	27	19

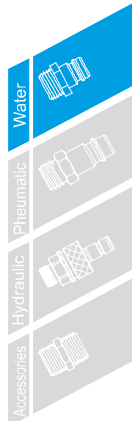

Plugs- Nippel



Plug & Extension plug with thread (T060 serie) Verlängerunsnippel mit Gewinde (T060 serie)

Order No - Bestell Nr.	d	d1	d2	L1	SW	Extension tube / Verlängerung		
						L60	L100	L150
T060 - ENM 8 x L	M8x0.75	5	9	7	11	60	100	150
T060 - ENM 10 x L	M10x1	6	9	7	11	60	100	150
T060 - EN 10-1.5 x L	LM10x1.5	6	9	9	11	60	100	150
T060 - EN 10 x L	G 1/8"	6	9	7	11	60	100	150
T060 - EN 13 x L	G 1/4"	6	9	9	14	60	100	150
T060 - ENM 14 x L	M14x1.5	6	9	9	14	60	100	150
T060 - EN 17 x L	G 3/8"	6	9	9	17	60	100	150

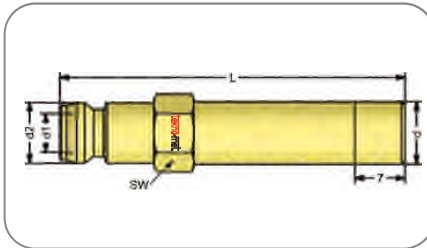

Plug & Extension plug with thread (T090 serie) Verlängerunsnippel mit Gewinde (T090 serie)

Order No - Bestell Nr.	d	d1	d2	L1	SW	Extension tube / Verlängerung		
						L60	L100	L150
T090 - EN 10 x L	G 1/8"	9	13	7	14	60	100	150
T090 - ENM 10 x L	M10x1	9	13	9	14	60	100	150
T090 - ENM 10x1.5 x L	LM10x1.5	9	13	9	14	60	100	150
T090 - ENM 12 x L	M12x1.5	9	13	9	14	60	100	150
T090 - EN 13 x L	G 1/4"	9	13	9	14	60	100	150
T090 - ENM 14 x L	M14x1.5	9	13	9	14	60	100	150
T090 - ENM 16 x L	M16x1.5	9	13	9	17	60	100	150
T090 - EN 17 x L	G 3/8"	9	13	9	17	60	100	150
T090 - EN 21 x L	G 1/2"	9	13	12	21	60	100	150

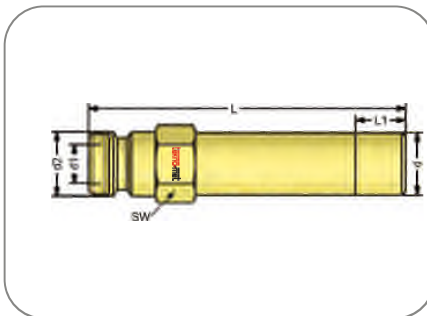

Plug with thread (T190 serie) Verlängerunsnippel mit Gewinde (T190 serie)

Order No - Bestell Nr.	d	d1	d2	L1	SW	Extension tube / Verlängerung		
						L60	L100	L150
T190 - EN 21	G 1/2"	13	19	12	22	250	500	800
T190 - ENM 24	M24x1.5	13	19	16	27	250	500	800
T190 - EN 26	G 3/4"	13	19	16	27	250	500	800

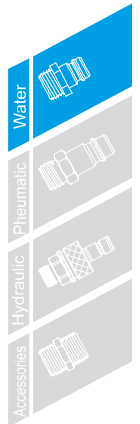
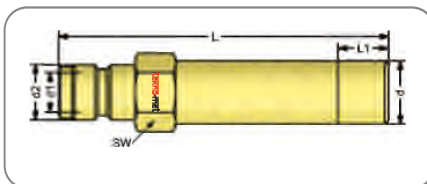

T060-T090-T190 Series

Plugs-Nippel



Long threaded plugs (T060 - T090 seri / serie) Gewindestecker (T060-T090)

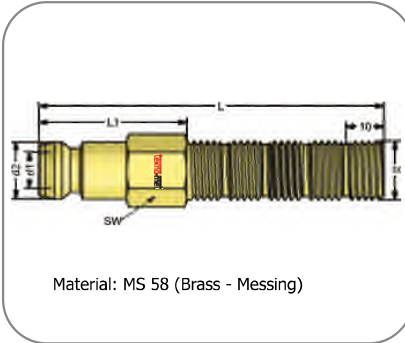

Order No - Bestell Nr.	Type	d	d1	d2	L1	L2	SW
T060 BLM 10x100	060	M10x10	6	9	40	100	11
T060 BL 10x100	060	G 1/8"	6	9	40	100	11
T060 BL 13x100	060	G 1/4"	6	9	40	100	14
T060 BLM 14x100	060	M14x1.5	6	9	40	100	14
T060 BL 17x100	060	G 3/8"	6	9	40	100	17
T090 BLM 10x100	090	M1x10	9	13	40	100	14
T090 BL 10x100	090	G 1/8"	9	13	40	100	14
T090 BL 13x100	090	G 1/4"	9	13	40	100	14
T090 BLM 14x100	090	M14x1.5	9	13	40	100	14
T090 BLM 16x100	090	M16x1.5	9	13	40	100	17
T090 BL 17x100	090	G 3/8"	9	13	40	100	17

Extension plug without thread Verlängerunsnippel ohne Gewinde

Material: MS 58 - Brass - Messing

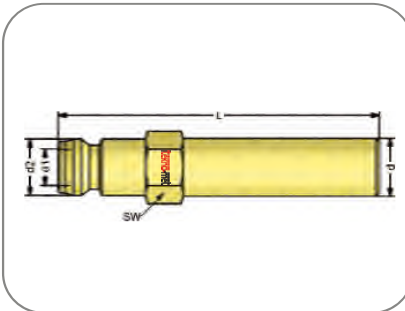

Order No - Bestell Nr.	Type	d	d1	d2	L1	L	SW
T060 BU 63	060	8	6	9	21	63	9
T060 BU 100	060	10	6	9	21	100	11
T060 BU 120	060	10	6	9	21	120	11
T060 BU 240	060	10	6	9	21	240	11
T060 BU 360	060	10	6	9	21	360	11
T090 BU 150	090	14	9	13	22	150	15
T090 BU 300	090	14	9	13	22	300	15
T090 BU 450	090	14	9	13	22	450	15
T190 BU 500	190	21	13	19	33	500	22
T190 BU 800	190	21	13	19	33	800	22

Steel Extension Tube Verlängerunsnippel aus Stahl

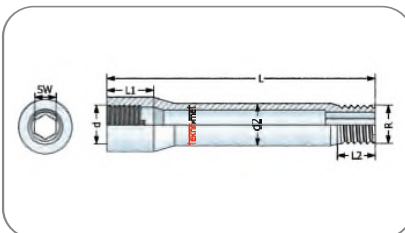

Order No - Bestell Nr.		d	R	d2	L	L1	L2	SW
BSP / BSPT	NPT / NPT							
TR 10 BU 50	TN 10 BU 50	1/8"	1/8"	10	50	12	10	5
TR 10 BU 75	TN 10 BU 75	1/8"	1/8"	10	75	12	10	5
TR 10 BU 100	TN 10 BU 100	1/8"	1/8"	10	100	12	10	5
TR 10 BU 125	TN 10 BU 125	1/8"	1/8"	10	125	12	10	5
TR 13 BU 50	TN 13 BU 50	1/4"	1/4"	14	50	12	10	8
TR 13 BU 75	TN 13 BU 75	1/4"	1/4"	14	75	12	10	8
TR 13 BU 100	TN 13 BU 100	1/4"	1/4"	14	100	12	10	8
TR 13 BU 125	TN 13 BU 125	1/4"	1/4"	14	125	12	10	8
TR 13 BU 150	TN 13 BU 150	1/4"	1/4"	14	150	12	10	8

Spare O-Rings (NBR) - Ersatz O-Ring (NBR)

Order No Bestell Nr.	Serie	Temperature
CG T060 N	060	-20° / 100° C -4° F / +212° F
CG T090 N	090	
CG T190 N	190	



Spare O-Rings (NBR) - Ersatz O-Ring (V)

Order No Bestell Nr.	Serie	Temperature
CG T060 V	060	-10° / 200° C +14° F / +392° F
CG T090 V	090	
CG T190 V	190	



Push-Pull

Sipariş No Order No	Seri Serie	d1	d2
SHF 10	T060 / T06	12	22
SHF 13	T090 / T09	15	24
SHF 19	T190 / T19	21	32

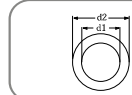

Plugs-Nippel

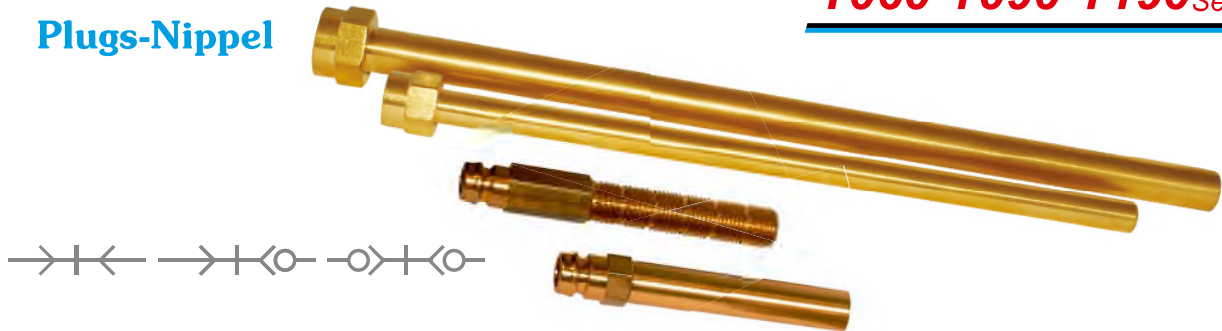

Sealing nipple extensions

Dichtungsnippel mit Verlängerunsnippel
Material : MS 58 (Brass - Messing)

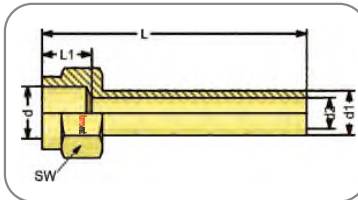

Order No - Bestell Nr.	d	d1	d2	t	L1	L	SW
TUN 14 - 120	M14x1.5	10	6	12	15.5	120	17
TUN 14 - 240	M14x1.5	10	6	12	15.5	240	17
TUN 16 - 150	M16x1.5	14	9	12	15.5	150	22
TUN 16 - 300	M16x1.5	14	9	12	15.5	300	22
TUN 24 - 500	M24x1.5	21	13	16	21	500	30
TUN 24 - 800	M24x1.5	21	13	16	21	800	30

Extension plug without thread

Verlängerunsnippel ohne Gewinde
Material : MS 58 - Brass - Messing

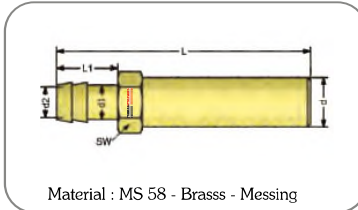

Order No - Bestell Nr.	d	d1	d2	L1	L	SW
TBHE 120	10	9	6	25	120	11
TBHE 240	10	9	6	25	240	11
TBHE 360	10	9	6	25	360	11
TBHE 150	14	13	9	33	150	15
TBHE 300	14	13	9	33	300	15
TBHE 450	14	13	9	33	450	15
TBHE 500	21	19	13	38	500	22

Cylindrical reduction

Reduzlernippel

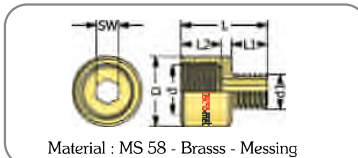

Order No - Bestell Nr.	d	d1	D	L	L1	L2	SW
TBDM 14/10	M14x1.5	M10x1	17	22	7	12	6
TBDM 13/10	G 1/4"	G 1/8"	17	22	7	12	6
TBDM 16/14	M16x1.5	M14x1.5	20	24	9	12	8
TBDM 17/13	G 3/8"	G 1/4"	20	24	9	12	8

Hose tail + Nut

Schlauchtüllen+ Überwurfmutter

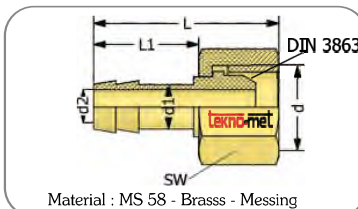

Order No - Bestell Nr.	d	d1	d2	L1	L	SW
TSN 14	M14x1.5	9	6	15.5	34.5	17
TSN 13	G 1/4"	9	6	15.5	34.5	17
TSN 16	M16x1.5	13	9	14	41	22
TSN 17	G 3/8"	13	9	14	41	22
TSN 24	M24x1.5	19	13	20	52	30
TSN 26	G 3/4"	19	13	20	52	32

Nippel 90°

Winkelrippel 90°

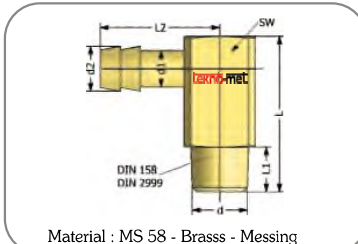

Order No - Bestell Nr.	d	d1	d2	L	L1	L2	SW
TAHE M8	M8x0.75	9	4.5	27	9	23	11
TAHE M10	M10x1	9	6	27	9	23	11
TAHE 10	R 1/8"	9	6	27	9	23	11
TAHE M14	M14x1.5	13	9	34	12	32.5	15
TAHE 13	R 1/4"	13	9	34	12	32.5	15
TAHE M24	M24x1.4	19	13	47	16	44	24
TAHE 21	R 1/2"	19	13	47	16	44	22

