

T6-T9-T16 Series

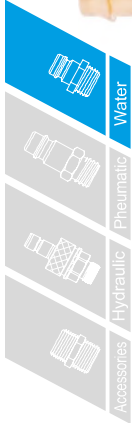

Material - Material

Coupler Body-
Kupplungsgrundkörper : Brass - Messing
Sleeve - Hülse : Brass - Messing
Springs - Federn : Stainless Steel -
Edelstahl

Locking O-Ring-
Sprengring : Stainless Steel -
Edelstahl

Balls - Kugeln : Stainless Steel -
Edelstahl

Seals - Dichtungen : Viton (V)
Plug - Nippel : Brass - Messing

Interchangeability - Kompatibilität

RECTUS 86-87-88, DME, FOSTER FJT,
PARKER MOLDMATE,
JIFFY TITE & JIFFY MATIC,

Temperature Range-Temperaturbereich

-20°C +100°C (-4°F +212°F) NITRIL (N)

-15°C +200°C (+5°F +392°F) VITON (V)

Working Pressure - Betriebsdruck

0 - 10 bar (0 - 145 PSI)

0 - 15 bar (0 - 217 PSI)

0 - 20 bar (0 - 290 PSI)

NW - 6 200 (1/4")

NW - 9 300 (3/8")

NW - 16 500 (1/2")

Standard version - Standardversion

Brass Messing

Viton Seal - Viton Dichtung

Options - Optionen

D - Double Shut off - beidseitig absperbar

N - Nickel plated - vernickelt

S - Stainless steel - Edelstahl

**Standart dışı siparişlerde istediğiniz
seçenek harfını**

sipariş no sonuna ekleyiniz.

For optional orders please add

the symbol of

your option end of the order number.

(T6 EG 13 N-S)

Using Area :

- On cooling system of plastic zamak, brass and aluminium injection moulds
- On cleaning and washing systems of machines
- On hot oil lines connection
- All industries
- On steam line

Nutzungsbereich:

- an Kühlsystemen für Kunststoff-, Zinkdruckguss-, Messing- und Aluminium-Kokillenformen
- Reinigungs und Waschsyste men von Maschinen
- Heissöleitungsanschlüssen
- Alle Industriezweige
- Dampfleitungen



With Valve - Mit Ventil
Order No - Bestell Nr.

Without Valve - Ohne Ventil
Order No - Bestell Nr.

Serie

d1

d2

d3

d4

L

L1

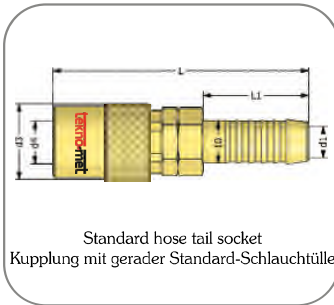

TVK 6 - 06

TK 6 - 06

200

4

6 - 1/4"

17

9

56

27

TVK 6 - 08

TK 6 - 08

200

6

8 - 5/16"

17

9

56

27

TVK 6 - 09

TK 6 - 09

200

7

9 - 5/14"

17

9

56

27

TVK 6 - 10

TK 6 - 10

200

8

10 - 3/8"

17

9

56

27

TVK 9 - 10

TK 9 - 10

300

8

10 - 3/8"

23

13

68

29

TVK 9 - 11

TK 9 - 11

300

9

11 - 7/16"

23

13

68

29

TVK 9 - 13

TK 9 - 13

300

10

13 - 1/2"

23

13

68

29

TVK 16 - 13

TK 16 - 13

500

10

13 - 1/2"

32

20

94

36

TVK 16 - 19

TK 16 - 19

500

16

19 - 3/4"

32

20

94

36



With Valve - Mit Ventil
Order No - Bestell Nr.

Without Valve - Ohne Ventil
Order No - Bestell Nr.

Serie

d1

d2

d3

d4

L

L1

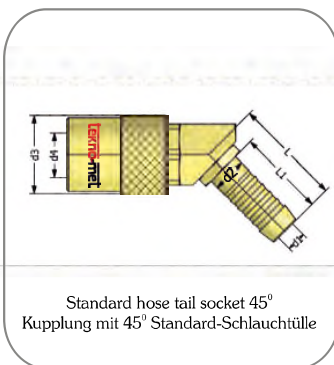

TVK 6 - 06 - 45°

TK 6 - 06 - 45°

200

4.5

6 - 1/4"

17

9

32

27

TVK 6 - 08 - 45°

TK 6 - 08 - 45°

200

6

8 - 5/16"

17

9

32

27

TVK 6 - 09 - 45°

TK 6 - 09 - 45°

200

6

9 - 5/14"

17

9

32

27

TVK 6 - 10 - 45°

TK 6 - 10 - 45°

200

6

10 - 3/8"

17

9

32

27

TVK 9 - 10 - 45°

TK 9 - 10 - 45°

300

8

10 - 3/8"

23

13

38

29

TVK 9 - 11 - 45°

TK 9 - 11 - 45°

300

9

11 - 7/16"

23

13

38

29

TVK 9 - 13 - 45°

TK 9 - 13 - 45°

300

10

13 - 1/2"

23

13

38

29

TVK 16 - 13 - 45°

TK 16 - 13 - 45°

500

10

13 - 1/2"

32

20

48

36

TVK 16 - 19 - 45°

TK 16 - 19 - 45°

5 00

16

19 - 3/4"

32

20

48

36



With Valve - Mit Ventil Order No - Bestell Nr.	Without Valve - Ohne Ventil Order No - Bestell Nr.	Serie	d1	d2	d3	d4	L
---	---	-------	----	----	----	----	---

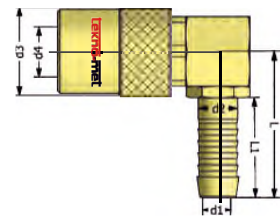

Standard hose tail socket 90°
Kupplung mit 90° Standard-Schlauchtülle

TVK 6 - 06 - 90°	TK 6 - 06 - 90°	200	4.5	6 - 1/4"	17	9	34
TVK 6 - 08 - 90°	TK 6 - 08 - 90°	200	6	8 - 5/16"	17	9	34
TVK 6 - 09 - 90°	TK 6 - 09 - 90°	200	7	9 - 5/14"	17	9	34
TVK 6 - 10 - 90°	TK 6 - 10 - 90°	200	8	10 - 3/8"	17	9	34
TVK 9 - 10 - 90°	TK 9 - 10 - 90°	300	8	10 - 3/8"	23	13	39
TVK 9 - 11 - 90°	TK 9 - 11 - 90°	300	9	11 - 7/16"	23	13	39
TVK 9 - 13 - 90°	TK 9 - 13 - 90°	300	10	13 - 1/2"	23	13	39
TVK 16 - 13 - 90°	TK 16 - 13 - 90°	500	10	13 - 1/2"	32	20	51
TVK 16 - 19 - 90°	TK 16 - 19 - 90°	500	16	19 - 3/4"	32	20	51



With Valve - Mit Ventil Order No - Bestell Nr.	Without Valve - Ohne Ventil Order No - Bestell Nr.	Serie	d1	d2	d3	d4	L
---	---	-------	----	----	----	----	---

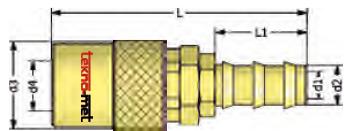

Push-Lock hose tail socket
Kupplung mit gerade Schnellsteck-Schlauchtülle

TVK 6 FG 06	TK 6 FG 06	200	5	6 - 1/4"	17	9	53
TVK 6 FG 10	TK 6 FG 10	200	7	10 - 3/8"	17	9	53
TVK 9 FG 10	TK 9 FG 10	300	8	10 - 3/8"	23	13	63
TVK 9 FG 13	TK 9 FG 13	300	10	13 - 1/2"	23	13	67
TVK 16 FG 13	TK 16 FG 13	500	10	13 - 1/2"	23	13	67
TVK 16 FG 16	TK 16 FG 16	500	13	16 - 5/8"	32	20	96
TVK 16 FG 19	TK 16 FG 19	500	15	19 - 3/4"	32	20	96



With Valve - Mit Ventil Order No - Bestell Nr.	Without Valve - Ohne Ventil Order No - Bestell Nr.	Serie	d1	d2	d3	d4	L
---	---	-------	----	----	----	----	---

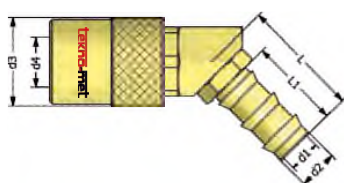

Push-Lock hose tail socket 45°
Kupplung mit 45° Schnellsteck-Schlauchtülle

TVK 6 FG 06 - 45°	TK 6 FG 06 - 45°	200	5	6 - 1/4"	17	9	29
TVK 6 FG 10 - 45°	TK 6 FG 10 - 45°	200	6	10 - 3/8"	17	9	29
TVK 9 FG 10 - 45°	TK 9 FG 10 - 45°	300	8	10 - 3/8"	23	13	29
TVK 9 FG 13 - 45°	TK 9 FG 13 - 45°	300	10	13 - 1/2"	23	13	37
TVK 16 FG 13 - 45°	TK 16 FG 13 - 45°	500	10	13 - 1/2"	32	20	47
TVK 16 FG 16 - 45°	TK 16 FG 16 - 45°	500	13	16 - 5/8"	32	20	57
TVK 16 FG 19 - 45°	TK 16 FG 19 - 45°	500	15	19 - 3/4"	32	20	57

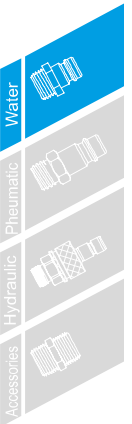

T6-T9-T16 Series

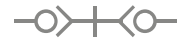
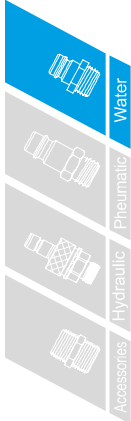

With Valve - Mit Ventil Order No - Bestell Nr.	Without Valve - Ohne Ventil Order No - Bestell Nr.	Serie	d1	d2	d3	d4	L	L1
---	---	-------	----	----	----	----	---	----

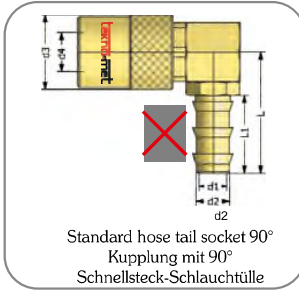

TVK 6 FG 10 - 90°	TK 6 FG 06 - 90°	200	4.5	6 - 1/4"	17	9	29	24
TVK 6 FG 10 - 90°	TK 6 FG 10 - 90°	200	6	10 - 3/8"	17	9	29	24
TVK 9 FG 10 - 90°	TK 9 FG 10 - 90°	300	8	10 - 3/8"	23	13	29	24
TVK 9 FG 13 - 90°	TK 9 FG 13 - 90°	300	10	13 - 1/2"	23	13	37	28
TVK 16 FG 13 - 90°	TK 16 FG 13 - 90°	500	10	13 - 1/2"	32	20	47	28
TVK 16 FG 16 - 90°	TK 16 FG 16 - 90°	500	13	16 - 5/8"	32	20	57	38
TVK 16 FG 19 - 90°	TK 16 FG 19 - 90°	500	15	19 - 3/4"	32	20	57	38



With Valve - Mit Ventil Order No - Bestell Nr.	Without Valve - Ohne Ventil Order No - Bestell Nr.	Serie	RP	d3	d4	L	L1
---	---	-------	----	----	----	---	----

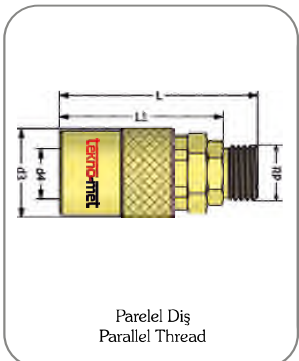

TVK 6 EG 10	TK 6 EG 10	200	G 1/8"	17	9	44	35
TVK 6 EG 13	TK 6 EG 13	200	G 1/4"	17	9	46	35
TVK 6 EG 14	TK 6 EG 14	200	M 14x1.5	17	9	46	35
TVK 6 EG 17	TK 6 EG 17	200	G 3/8"	17	9	46	35
TVK 9 EG 13	TK 9 EG 13	300	G 1/4"	23	13	56	45
TVK 9 EG 16	TK 9 EG 16	300	M 16x1.5	23	13	56	45
TVK 9 EG 17	TK 9 EG 17	300	G 3/8"	23	13	56	45
TVK 9 EG 18	TK 9 EG 18	300	M 18x1.5	23	13	56	45
TVK 9 EG 21	TK 9 EG 21	300	G 1/2"	23	13	56	45
TVK 16 EG 21	TK 16 EG 21	500	G 1/2"	32	20	80	65
TVK 16 EG 26	TK 16 EG 26	500	G 3/4"	32	20	82	65

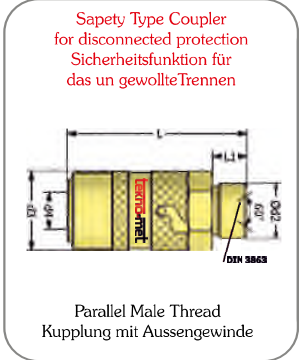

TVK 6 EG 10/EM*	TK 6 EG 10/EM	200	G 1/8"	17	9	50	35
TVK 6 EG 13/EM	TK 6 EG 13/EM	200	G 1/4"	17	9	50	35
TVK 6 EG 14/EM	TK 6 EG 14/EM	200	M 14x1.5	17	9	50	35
TVK 6 EG 17/EM	TK 6 EG 17/EM	200	G 3/8"	17	9	50	35
TVK 9 EG 13/EM	TK 9 EG 13/EM	300	G 1/4"	23	13	64	45
TVK 9 EG 16/EM	TK 9 EG 16/EM	300	M 16x1.5	23	13	64	45
TVK 9 EG 17/EM	TK 9 EG 17/EM	300	G 3/8"	23	13	64	45
TVK 9 EG 18/EM	TK 9 EG 18/EM	300	M 18x1.5	23	13	64	45
TVK 9 EG 21/EM	TK 9 EG 21/EM	300	G 1/2"	23	13	64	45
TVK 16 EG 21/EM	TK 16 EG 21/EM	500	G 1/2"	32	20	90	65
TVK 16 EG 26/EM	TK 16 EG 26/EM	500	G 3/4"	32	20	92	65

* If you order this way, add "EM" at the of product code



With Valve - Mit Ventil Order No - Bestell Nr.	Without Valve - Ohne Ventil Order No - Bestell Nr.	Serie	NPT	d3	d4	L	L1
---	---	-------	-----	----	----	---	----

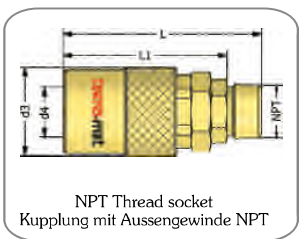

TVK 6 TG 10	TK 6 TG 10	200	NPT 1/8"	17	9	44	35
TVK 6 TG 13	TK 6 TG 13	200	NPT 1/4"	17	9	47	35
TVK 9 TG 13	TK 9 TG 13	300	NPT 1/4"	23	13	57	45
TVK 9 TG 17	TK 9 TG 17	300	NPT 3/8"	23	13	61	45
TVK 16 TG 21	TK 16 TG 21	500	NPT 1/2"	32	20	80	65

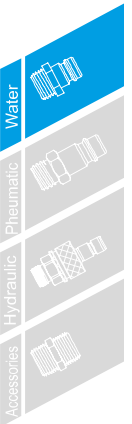

With Valve - Mit Ventil Order No - Bestell Nr.	Without Valve - Ohne Ventil Order No - Bestell Nr.	Serie	RP	d3	d4	L	L1
---	---	-------	----	----	----	---	----

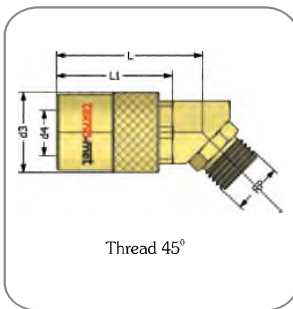

TVK 6 EG 10 - 45°	TK 6 EG 10 - 45°	200	G 1/8"	17	9	38	30
TVK 6 EG 13 - 45°	TK 6 EG 13 - 45°	200	G 1/4"	17	9	38	30
TVK 9 EG 13 - 45°	TK 9 EG 13 - 45°	300	G 1/4"	23	13	50	40
TVK 9 EG 16 - 45°	TK 9 EG 16 - 45°	300	M 16x1.5	23	13	50	40
TVK 9 EG 17 - 45°	TK 9 EG 17 - 45°	300	G 3/8"	23	13	50	40
TVK 9 EG 21 - 45°	TK 9 EG 21 - 45°	300	G 1/2"	23	13	50	40
TVK 16 EG 21 - 45°	TK 16 EG 21 - 45°	500	G 1/2"	32	20	72	57



With Valve - Mit Ventil Order No - Bestell Nr.	Without Valve - Ohne Ventil Order No - Bestell Nr.	Serie	RP	d3	d4	L	L1
---	---	-------	----	----	----	---	----

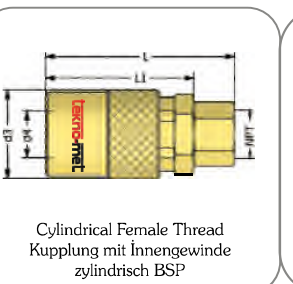

TVK 6 DG 10	TK 6 DG 10	200	G 1/8"	17	19	40	30
TVK 6 DG 13	TK 6 DG 13	200	G 1/4"	17	9	42	30
TVK 6 DG 14	TK 6 DG 14	200	M 14x1.5	17	9	42	30
TVK 6 DG 17	TK 6 DG 17	200	G 3/8"	17	9	42	30
TVK 9 DG 13	TK 9 DG 13	300	G 1/4"	23	13	52	40
TVK 9 DG 17	TK 9 DG 17	300	G 3/8"	23	13	52	40
TVK 9 DG 21	TK 9 DG 21	300	G 1/2"	23	13	57	40
TVK 16 DG 21	TK 16 DG 21	500	G 1/2"	30	20	75	57



With Valve - Mit Ventil Order No - Bestell Nr.	Without Valve - Ohne Ventil Order No - Bestell Nr.	Serie	NPT	d3	d4	L	L1
---	---	-------	-----	----	----	---	----

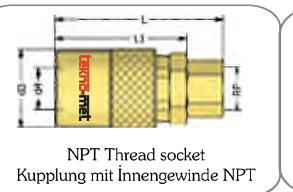

TVK 6 NG 10	TK 6 NG 10	200	NPT 1/8"	17	9	42	30
TVK 6 NG 13	TK 6 NG 13	200	NPT 1/4"	17	9	45	30
TVK 9 NG 13	TK 9 NG 13	300	NPT 1/4"	23	13	56	41
TVK 9 NG 17	TK 9 NG 17	300	NPT 3/8"	23	13	57	41
TVK 16 NG 21	TK 16 NG 21	500	NPT 1/2"	30	20	80	57

T6-T9-T16 Series

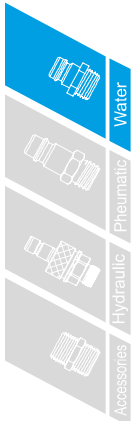

With Valve - Mit Ventil
Order No - Bestell Nr.

Without Valve - Ohne Ventil
Order No - Bestell Nr.

Serie

NPT

d3

d4

L

L1

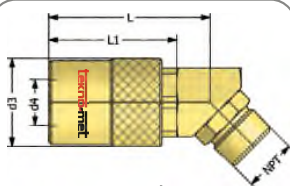

NPT Thread socket 45°
Kupplung mit 45° Aussengewinde NPT

TVK 6 TG 10 - 45°

TK 6 TG 10 - 45°

200

NPT 1/8"

17

9

38

30

TVK 6 TG 13 - 45°

TK 6 TG 13 - 45°

200

NPT 1/4"

17

9

38

30

TVK 9 TG 13 - 45°

TK 9 TG 13 - 45°

300

NPT 1/4"

23

13

50

40

TVK 9 TG 17 - 45°

TK 9 TG 17 - 45°

300

NPT 3/8"

23

13

50

40

TVK 16 TG 21 - 45°

TK 16 TG 21 - 45°

500

NPT 1/2"

32

20

72

57



With Valve - Mit Ventil
Order No - Bestell Nr.

Without Valve - Ohne Ventil
Order No - Bestell Nr.

Serie

RP

d3

d4

L

L1

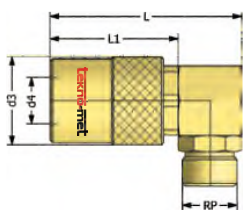

Cylindrical Thread socket 90°
Kupplung mit 90° Aussengewinde
zylindrisch BSP

TVK 6 EG 10 - 90°

TK 6 EG 10 - 90°

200

G 1/8"

17

9

38

30

TVK 6 EG 13 - 90°

TK 6 EG 13 - 90°

200

G 1/4"

17

9

38

30

TVK 9 EG 13 - 90°

TK 9 EG 13 - 90°

300

G 1/4"

23

13

50

40

TVK 9 EG 16 - 90°

TK 9 EG 16 - 90°

300

M 16x1.5

23

13

50

40

TVK 9 EG 17 - 90°

TK 9 EG 17 - 90°

300

G 3/8"

23

13

50

40

TVK 9 EG 21 - 90°

TK 9 EG 21 - 90°

300

G 1/2"

23

13

50

40

TVK 16 EG 21 - 90°

TK 16 EG 21 - 90°

500

G 1/2"

32

20

72

57



With Valve - Mit Ventil
Order No - Bestell Nr.

Without Valve - Ohne Ventil
Order No - Bestell Nr.

Serie

NPT

d3

d4

L

L1

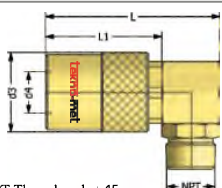

NPT Thread socket 45°
Kupplung mit 45° Aussengewinde NPT

TVK 6 TG 10 - 90°

TK 6 TG 10 - 90°

200

NPT 1/8"

17

9

38

30

TVK 6 TG 13 - 90°

TK 6 TG 13 - 90°

200

NPT 1/4"

17

9

38

30

TVK 9 TG 13 - 90°

TK 9 TG 13 - 90°

300

NPT 1/4"

23

13

50

40

TVK 9 TG 17 - 90°

TK 9 TG 17 - 90°

300

NPT 3/8"

23

13

50

40

TVK 16 TG 21 - 90°

TK 16 TG 21 - 90°

500

NPT 1/2"

32

20

72

57



Blind Socket / Blindkupplung

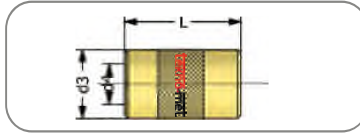

Order No - Bestell Nr.	Serie	d3	d4	L
T6 KTG 00	200	17	9	27
T9 KTG 00	300	23	13	35

Adapting Socket with Plug Adapterkupplung mit nippel

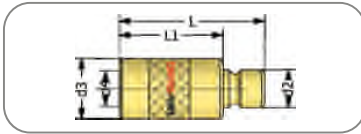

With Valve - Mit Ventil Order No - Bestell Nr.	Without Valve - Ohne Ventil Order No - Bestell Nr.	Serie	d 2	d3	d4	L	L1
TVK 6 AU 09	TK 6 AU 09	200	13	17	9	43	27.5
TVK 9 AU 06	TK 9 AU 06	300	9	23	13	51	36

Adapting Socket with T060 - T090 Plugs Adapterkupplung mit T060 - T090 nippel

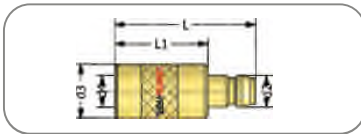

With Valve - Mit Ventil Order No - Bestell Nr.	Without Valve - Ohne Ventil Order No - Bestell Nr.	Serie	d 2	d3	d4	L	L1
TVK 6 AU 060	TK 6 AU 060	200	9	17	9	41.5	27.5
TVK 9 AU 090	TK 9 AU 090	300	13	23	13	50	36

Adapting Socket with T100.08 Plug Adapterkupplung mit T100.08 nippel

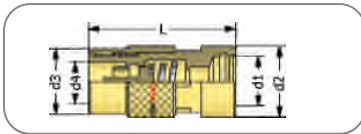

With Valve - Mit Ventil Order No - Bestell Nr.	Without Valve - Ohne Ventil Order No - Bestell Nr.	Serie	d1	d 2	d3	d4	L
TVK 6 AU 100.08	TK 6 AU 100.08	200	17	21	17	9	46.5
TVK 9 AU 100.08	TK 9 AU 100.08	300	17	21	23	13	52

Adapting Plug - Adapternippel

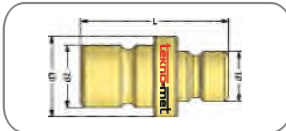

Order No Bestell Nr.	d1	d 2	d3	L
T9 HEF 06	9	13	15	32

Stop Plugs - Blindnippel

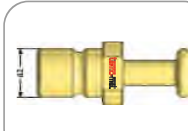

Sipariş No Order No	Serie	d2
T6 KTU 00	200 (1/4")	9
T9 KTU 00	300 (3/8")	13
T16 KTU 00	500 (1/2")	20

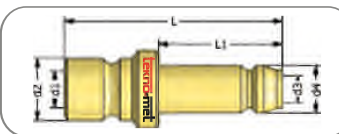

Order No Bestell Nr.	d1	d 2	d3	d4	L1	L
T06/T060	5.5	9.5	6	9	14	29
T09/T090	8	13.5	9	13.5	14	35

Flexible Diverting connector - Umlenkupplung mit Schnellsteck-Schlauchtülle

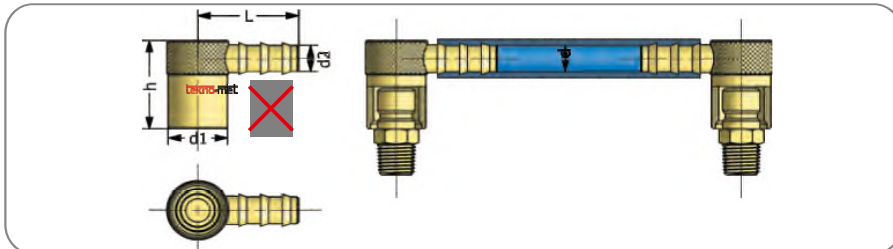

Order No Bestell Nr.	Serie	Hose Inner dia.	h		L		d1		d2	
			mm	inch.	mm	inch.	mm	inch.	mm	inch.
TK 6 KG-10	6	10 - 3/8"	25.4	1.00	31.8	1.25	17	0.67	9.7	0.375
TK 9 KG 13	9	13 - 1/2"	36.3	1.43	39.6	1.56	23	0.90	12.7	0.500

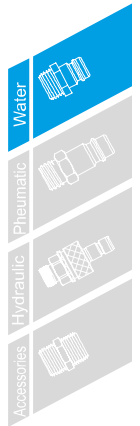

T6-T9-T16 Series



Wenn Sie Kupplungen
Mit Sicherheit bestellen
Bitte am ende der
bestell-NR OCB hinzufügen
Beispiel: CSK09-13 OCB

If you order couplings with
safety please add OCB at
the end of the order number
Example: CSK09-13 OCB

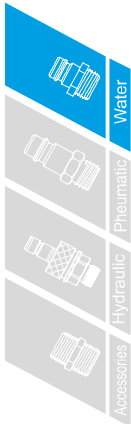
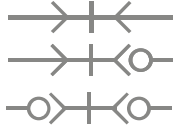

Diverting connector Umlenkkuplung

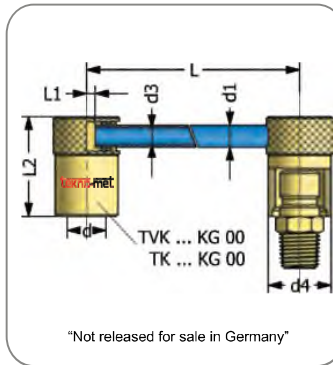

"Not released for sale in Germany"



With Valve - Mit Ventil
Order No - Bestell Nr.

Without Valve - Ohne Ventil
Order No - Bestell Nr.

Serie	d	d1	d2	d3	d4	L1	L2	L		
TVK T6 - KG125	TK T6 - KG125	200,	9	8	20	6	17	0	41	125
TVK T6 - KG250	TK T6 - KG250	200	9	8	20	6	17	0	41	250
TVK T6 - KG500	TK T6 - KG500	200	9	8	20	6	17	0	41	500
TVK T9 - KG125	TK T9 - KG125	300	13	10	26	8	22	2	52.5	125
TVK T9 - KG250	TK T9 - KG250	300	13	10	26	8	22	2	52.5	250
TVK T9 - KG500	TK T9 - KG500	300	13	10	26	8	22	2	52.5	500
TVK T16 - KG160	TK T16 - KG160	500	20	14	36	12	31	2	65	160
TVK T16 - KG315	TK T16 - KG315	500	20	14	36	12	31	2	65	315
TVK T16 - KG500	TK T16 - KG500	500	20	14	36	12	31	2	65	500

Push-Lock Hose Plug Stecknippel mit Schellsteck-Schlauchtülle

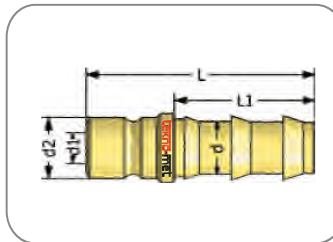

Order No Bestell Nr.	Serie	d / I.D		d1	d2	L1		L	
		mm	inch.			mm	inch.	mm	inch.
T6 FU 10	200	10	3/8"	6	9	24	0.95	37	1.4
T6 FU 13	200	13	1/2"	6	9	24	1.10	39.5	1.56
T9 FU 10	300	10	3/8"	9	13	24	0.95	45	1.75
T9 FU 13	300	13	1/2"	9	13	28	1.10	48	1.86
T16 FU 13	500	13	1/2"	15	20	28	1.10	50.8	2.00
T16 FU 19	500	19	3/4"	15	20	28	1.50	63.5	2.50

Standard Hose plug Standard Schlauchtülle

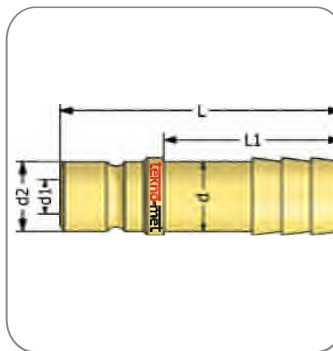

Order No Bestell Nr.	Serie	d	d1	d2	L	L1
T6 HU 06	300	6 - 1/4"	6	9	37	23
T6 HU 08	300	8 - 5/16"	6	9	37	23
T6 HU 09	300	9 - 5/14"	6	9	37	23
T6 HU 10	300	10 - 3/8"	6	9	37	23
T9 HU 09	300	9 - 5/14"	9	13	45	26
T9 HU 10	300	10 - 3/8"	9	13	45	26
T9 HU 11	300	11 - 7/16"	9	13	45	26
T9 HU 13	300	13 - 1/2"	9	13	44.5	26
T16 HU 13	500	13 - 1/2"	15	20	50	27
T16 HU 20	500	20 - 3/4"	15	20	50	27



Plug with conical male thread Nippel mit konischem Aussengewinde

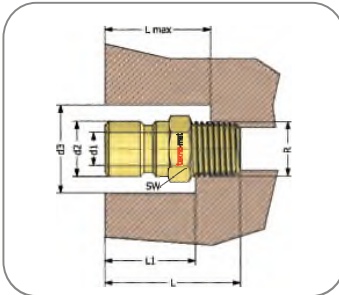

Order No / Bestell Nr.		Serie	R	d1	d2	d3	SW	L1	L max	L
BSPT	NPT									
T6 EN 10	T6 TU 10	6	1/8"	6	9	22	13	17	18	24
T6 EN 13	T6 TU 13	6	1/4"	6	9	26	14	19	20	29
T6 EN 17	T6 TU 17	6	3/8"	6	9	30	19	21	22	30
T9 EN 10	T9 TU 10	9	1/8"	9	13	26	14	25	26	30
T9 EN 13	T9 TU 13	9	1/4"	9	13	26	16	25	26	33
T9 EN 17	T9 TU 17	9	3/8"	9	13	60	19	26	28	34
T9 EN 21	T9 TU 21	9	1/2"	9	13	37	22	26	28	39
T16 EN 13	T16 TU 13	16	1/4"	15	20	30	21	28	32	41
T16 EN 17	T16 TU 17	16	3/8"	15	20	32	21	28	32	35
T16 EN 21	T16 TU 21	16	1/2"	15	20	32	22	37	38	44
T16 EN 26	T16 TU 26	16	3/4"	15	20	38	29	38	40	45

Plug with cylindrical male thread Nippel mit zylindrisches Aussengewinde

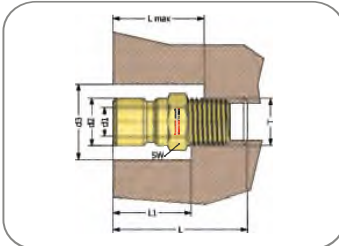

Order No / Bestell Nr.		Serie	T	d1	d2	d3	SW	L1	L max	L
T6 EU 13										
T6 EU 17		6	G3/8"	9	13	30	19	20	22	34
T16 EU 17		16	G3/8"	15	20	32	22	25	25	40
T16 EU 21		16	G1/2"	15	20	32	22	25	25	45
T6 EU 10		6	M10x1	6	9	22	11	17	18	24
T6 EU 14		6	M14x1.5	6	9	26	14	19	20	25
T9 EU 10		9	M10x1	9	13	26	14	25	26	30
T9 EU 14		9	M14x1.5	9	13	26	14	25	26	30

Shut-off Male threaded plug Verschlussnippel mit Aussengewinde

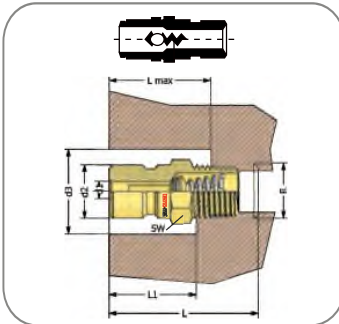

Order No / Bestell Nr.		Serie	R	d1	d2	d3	SW	L1	L max	L
BSPT	NPT									
T6 EN 13 V	T6 TU 13 V	6	1/4"	6	9	28	14	19	21	29
T6 EN 17 V	T6 TU 17 V	6	3/8"	6	9	30	17	21	21	29
T6 EN 13 V	T6 TU 13 V	6	1/4"	9	13	28	14	25	21	33
T6 EN 17 V	T6 TU 17 V	6	3/8"	9	13	30	17	26	21	33
T6 EN 21 V	T6 TU 21 V	6	1/2"	9	13	32	22	26	28	37
T6 EN 21 V	T6 TU 21 V	6	1/2"	15	20	32	22	28	28	50
T6 EN 21 V	T6 TU 21 V	6	3/4"	15	20	38	27	32	32	50
T6 ENM 14 V		6	M14x1.5	6	9	28	14	21	21	29
T9 ENM 14 V		9	M14x1.5	9	13	28	14	25	21	34

Plug with female thread Nippel mit Innengewinde

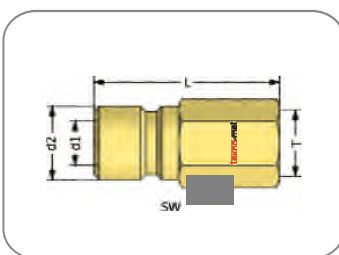

Order No / Bestell Nr.		Serie	T	d1	d2	L	SW
BSPT	NPT						
T6 DU 10	T6 NU 10	6	1/8"	6	9	26	13
T6 DU 13	T6 NU 13	6	1/4"	6	9	32	16
T6 DU 17	T6 NU 17	6	3/8"	6	9	32	19
T9 DU 10	T9 NU 10	9	1/8"	9	13	29	14
T9 DU 13	T9 NU 13	9	1/4"	9	13	37	16
T9 DU 17	T9 NU 17	9	3/8"	9	13	39	19
T9 DU 21	T9 NU 21	9	1/2"	9	13	40	24
T16 DU 17	T16 NU 17	16	3/8"	15	20	32	21
T16 DU 21	T16 NU 21	16	1/2"	15	20	35	24

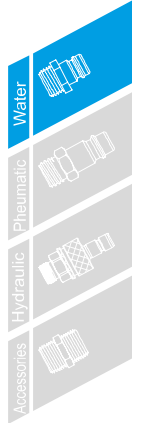

T6-T9-T16 Series



Long Threaded Plugs Gewindestecker

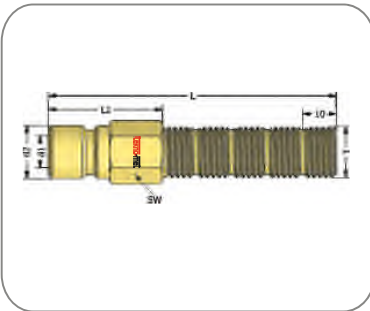

Order No / Bestell Nr.	T	d1	d2	SW	L	L1
T6 BLM 10x100	M10x1	6	9.4	11	100	40
T6 BL 10x100	G 1/8"	6	9.4	11	100	40
T6 BL 13x100	G 1/4"	6	9.4	14	100	40
T6 BLM 14x100	M 14x1.5	6	9.4	14	100	40
T6 BL 17x100	G 3/8"	6	9.4	17	100	40
T9 BLM 10x100	M 10x1	9	13.5	14	100	40
T9 BL 10x100	G 1/8"	9	13.5	14	100	40
T9 BL 13x100	G 1/4"	9	13.5	14	100	40
T9 BLM 14x100	M14x1.5	9	13.5	14	100	40
T9 BLM 16x100	M16x1.5	9	13.5	17	100	40
T9 BL 17x100	G 3/8"	9	13.5	17	100	40

Extension plug without thread Verlängerungsnipl ohne Gewinde

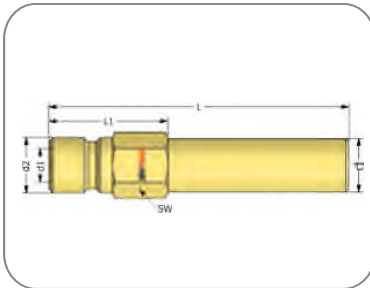

Order No / Bestell Nr.	d	d1	d2	SW	L	L1
T6 BN 63	10	6	9.4	11	63	17
T6 BN 100	10	6	9.4	11	100	17
T6 BN 120	10	6	9.4	11	120	17
T6 BN 240	10	6	9.4	11	240	17
T6 BN 360	10	6	9.4	11	360	17
T9 BN 150	14	9	13	15	150	23
T9 BN 300	14	9	13	15	300	23
T9 BN 450	14	9	13	15	450	23
T16 BN 500	21	15	20	22	500	30
T16 BN 800	21	15	20	22	800	30

Extension plug Verlängerungsnipl

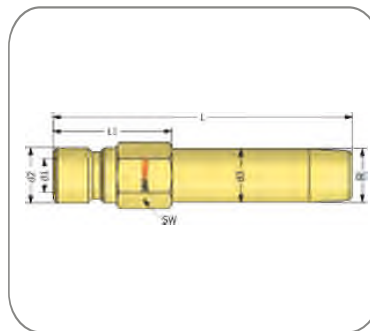

Order No / Bestell Nr.		R	SW	d1	d2	d3	L50	L100	L150	L200	L250
BSPT	NPT										
T6 EN 10xL	T6 TU 10xL	1/8"	11	6	9	10	50	100	150	200	250
T6 EN 13xL	T6 TU 13xL	1/4"	14	6	9	14	50	100	150	200	250
T6 EN 17xL	T6 TU 17xL	3/8"	17	6	9	17	50	100	150	200	250
T9 EN 13xL	T9 TU 13xL	1/4"	15	9	13	14	50	100	150	200	250
T9 EN 17xL	T9 TU 17xL	3/8"	17	9	13	17	50	100	150	200	250

Order No / Bestell Nr.	R	SW	d1	d2	d3	L50	L100	L150	L200	L250
T6 ENM 10xL	M10x1	11	10	9	6	50	100	150	200	250
T6 ENM 14xL	M14x1.5	15	14	9	6	50	100	150	200	250
T9 ENM 14xL	M14x1.5	15	14	13	9	50	100	150	200	250

Angle plug with 90° Winkelnippl mit 90°

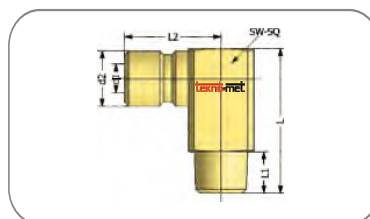

Order No / Bestell Nr.	R	d1	d2	L	L1	L2	SW/SQ
T6 EN 10 - 90	BSPT 1/8"	6	9	27	9	23	11
T6 ENM 10 - 90	M 10x1	6	9	27	9	23	11
T6 EN 13 - 90	BSPT 1/4"	6	9	34	12	24	15
T6 EN 14 - 90	M14x1.5	6	9	34	12	24	15
T6 EN 17 - 90	BSPT 3/8"	6	9	34	12	24	17
T9 EN 13 - 90	BSPT 1/4"	9	13	34	12	24	15
T9 EN 17 - 90	BSPT 3/8"	9	13	34	12	24	17



Extension Plugs with tapered and long parallel thread
 The largest complete thread on the standard NPT or BSPT taper is continued along the extension plug for the 1 5/8" (41.5 mm) shown below easy adjustments if needed.

Verlängerungsrippel mit Außengewinde konisch
 Die erste Gewindestufe der konisch ausgeführten Nippel ermöglicht einen sehr flexiblen Einsatzbereich.

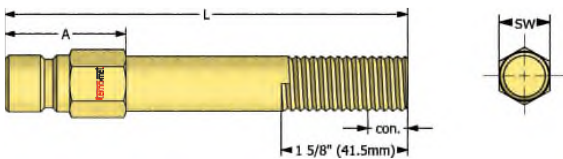

Serie & Thread	Order No / Bestell Nr.		A		L	
	NPT	BSPT	mm	inch.	mm	inch.
9 1/8"	T9 NL10x63	T9 RL10x63	22.2	7/8"	63.5	2.5"
	T9 NL10x101	T9 RL10x101	25.4	1"	101.6	4"
	T9 NL10x140	T9 RL10x140	25.4	1"	140	5.5"
	T9 NL10x178	T9 RL10x178	25.4	1"	178	7"
	T9 NL10x216	T9 RL10x216	25.4	1"	216	8.5"
	T9 NL10x254	T9 RL10x254	25.4	1"	254	10"
	T9 NL10x292	T9 RL10x292	25.4	1"	292	11.5"
	T9 NL10x330	T9 RL10x330	25.4	1"	330	13"

Serie & Thread	Order No / Bestell Nr.		A		L	
	NPT	BSPT	mm	inch.	mm	inch.
6 1/8"	T6 NL10x63	T6 RL10x63	22.2	11/16"	63.5	2.5"
	T6 NL10x101	T6 RL10x101	25.4	1"	101.6	4"
	T6 NL10x140	T6 RL10x140	25.4	1"	140	5.5"
	T6 NL10x178	T6 RL10x178	25.4	1"	178	7"
	T6 NL10x216	T6 RL10x216	25.4	1"	216	8.5"
	T6 NL10x254	T6 RL10x254	25.4	1"	254	10"
	T6 NL10x292	T6 RL10x292	25.4	1"	292	11.5"
	T6 NL10x330	T6 RL10x330	25.4	1"	330	13"

Serie & Thread	Order No / Bestell Nr.		A		L	
	NPT	BSPT	mm	inch.	mm	inch.
9 1/4"	T9 NL13x63	T9 RL13x63	22.2	7/8"	63.5	2.5"
	T9 NL13x101	T9 RL13x101	31.7	1.25"	101.6	4"
	T9 NL13x140	T9 RL13x140	31.7	1.25"	140	5.5"
	T9 NL13x178	T9 RL13x178	31.7	1.25"	178	7"
	T9 NL13x216	T9 RL13x216	31.7	1.25"	216	8.5"
	T9 NL13x254	T9 RL13x254	31.7	1.25"	254	10"
	T9 NL13x292	T9 RL13x292	31.7	1.25"	292	11.5"
	T9 NL13x330	T9 RL13x330	31.7	1.25"	330	13"

Serie & Thread	Order No / Bestell Nr.		A		L	
	NPT	BSPT	mm	inch.	mm	inch.
6 1/4"	T6 NL13x63	T6 RL13x63	22.2	7/8"	63.5	2.5"
	T6 NL13x101	T6 RL13x101	31.7	1.25"	101.6	4"
	T6 NL13x140	T6 RL13x140	31.7	1.25"	140	5.5"
	T6 NL13x178	T6 RL13x178	31.7	1.25"	178	7"
	T6 NL13x216	T6 RL13x216	31.7	1.25"	216	8.5"
	T6 NL13x254	T6 RL13x254	31.7	1.25"	254	10"
	T6 NL13x292	T6 RL13x292	31.7	1.25"	292	11.5"
	T6 NL13x330	T6 RL13x330	31.7	1.25"	330	13"

Serie & Thread	Order No / Bestell Nr.		A		L	
	NPT	BSPT	mm	inch.	mm	inch.
9 3/8"	T9 NL17x63	T9 RL17x63	25.4	1"	63.5	2.5"
	T9 NL17x101	T9 RL17x101	31.7	1.25"	101.6	4"
	T9 NL17x140	T9 RL17x140	31.7	1.25"	140	5.5"
	T9 NL17x178	T9 RL17x178	31.7	1.25"	178	7"
	T9 NL17x216	T9 RL17x216	31.7	1.25"	216	8.5"
	T9 NL17x254	T9 RL17x254	31.7	1.25"	254	10"
	T9 NL17x292	T9 RL17x292	31.7	1.25"	292	11.5"
	T9 NL17x330	T9 RL17x330	31.7	1.25"	330	13"

Serie & Thread	Order No / Bestell Nr.		A		L	
	NPT	BSPT	mm	inch.	mm	inch.
6 3/8"	T6 NL17x63	T6 RL17x63	25.4	1"	63.5	2.5"
	T6 NL17x101	T6 RL17x101	31.7	1.25"	101.6	4"
	T6 NL17x140	T6 RL17x140	31.7	1.25"	140	5.5"
	T6 NL17x178	T6 RL17x178	31.7	1.25"	178	7"
	T6 NL17x216	T6 RL17x216	31.7	1.25"	216	8.5"
	T6 NL17x254	T6 RL17x254	31.7	1.25"	254	10"
	T6 NL17x292	T6 RL17x292	31.7	1.25"	292	11.5"
	T6 NL17x330	T6 RL17x330	31.7	1.25"	330	13"

Serie & Thread	Order No / Bestell Nr.		A		L	
	NPT	BSPT	mm	inch.	mm	inch.
9 1/2"	T9 NL21x63	T9 RL21x63	25.4	1"	63.5	2.5"
	T9 NL21x101	T9 RL21x101	31.7	1.25"	101.6	4"
	T9 NL21x140	T9 RL21x140	31.7	1.25"	140	5.5"
	T9 NL21x178	T9 RL21x178	31.7	1.25"	178	7"
	T9 NL21x216	T9 RL21x216	31.7	1.25"	216	8.5"
	T9 NL21x254	T9 RL21x254	31.7	1.25"	254	10"
	T9 NL21x292	T9 RL21x292	31.7	1.25"	292	11.5"
	T9 NL21x330	T9 RL21x330	31.7	1.25"	330	13"

Serie & Thread	Order No / Bestell Nr.		A		L	
	NPT	BSPT	mm	inch.	mm	inch.
16 3/8"	T16 NL21x63	T16 RL21x63	28.5	1.25"	63.5	2.5"
	T16 NL21x101	T16 RL21x101	35	1.5"	101.6	4"
	T16 NL21x140	T16 RL21x140	35	1.5"	140	5.5"
	T16 NL21x178	T16 RL21x178	35	1.5"	178	7"
	T16 NL21x216	T16 RL21x216	35	1.5"	216	8.5"
	T16 NL21x254	T16 RL21x254	35	1.5"	254	10"
	T16 NL21x292	T16 RL21x292	35	1.5"	292	11.5"
	T16 NL21x330	T16 RL21x330	35	1.5"	330	13"

Serie & Thread	Order No / Bestell Nr.		A		L	
	NPT	BSPT	mm	inch.	mm	inch.
16 1/2"	T16 NL21x63	T16 RL21x63	28.5	1.25"	63.5	2.5"
	T16 NL21x101	T16 RL21x101	38	1.5"	101.6	4"
	T16 NL21x140	T16 RL21x140	38	1.5"	140	5.5"
	T16 NL21x178	T16 RL21x178	38	1.5"	178	7"
	T16 NL21x216	T16 RL21x216	38	1.5"	216	8.5"
	T16 NL21x254	T16 RL21x254	38	1.5"	254	10"
	T16 NL21x292	T16 RL21x292	38	1.5"	292	11.5"
	T16 NL21x330	T16 RL21x330	38	1.5"	330	13"



T6-T9-T16 Series

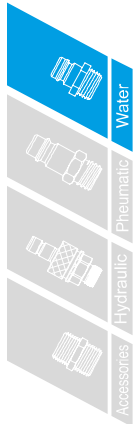

Steel Extension Tube Verlängerungsrohr aus Stahl

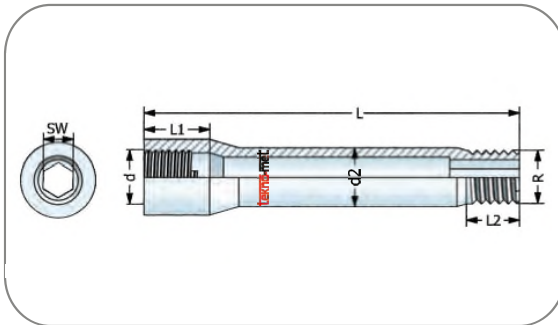

Order No / Bestell Nr.		d	R	d2	L	L1	L2	SW
BSP / BSPT	NPT / NPT							
TR 10 BU 50	TN 10 BU 50	1/8"	1/8"	10	50	12	10	5
TR 10 BU 75	TN 10 BU 75	1/8"	1/8"	10	75	12	10	5
TR 10 BU 100	TN 10 BU 100	1/8"	1/8"	10	100	12	10	5
TR 10 BU 125	TN 10 BU 125	1/8"	1/8"	10	125	12	10	5
TR 13 BU 50	TN 13 BU 50	1/4"	1/4"	14	50	12	10	8
TR 13 BU 75	TN 13 BU 75	1/4"	1/4"	14	75	12	10	8
TR 13 BU 100	TN 13 BU 100	1/4"	1/4"	14	100	12	10	8
TR 13 BU 125	TN 13 BU 125	1/4"	1/4"	14	125	12	10	8
TR 13 BU 150	TN 13 BU 150	1/4"	1/4"	14	150	12	10	8

Extension tube Verlängerungsrohr

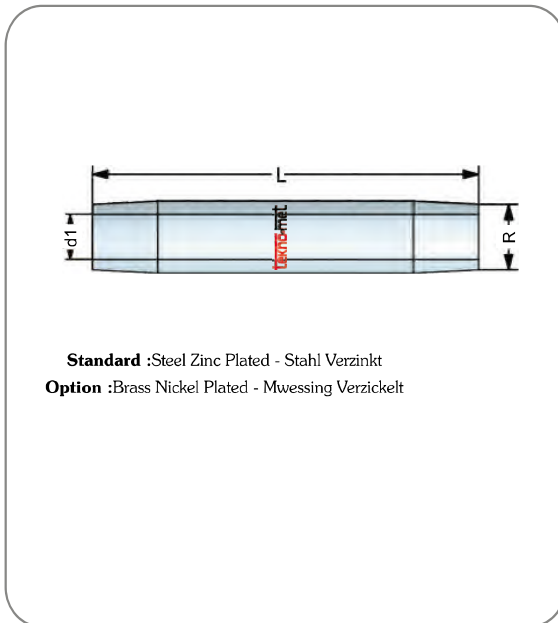

Order No / Bestell Nr.		R	d	d1	L
BSPT	NPT				
T6 BU 50	T6 NBU 50	1/8"	10	6	50
T6 BU 100	T6 NBU 100	1/8"	10	6	100
T6 BU 150	T6 NBU 150	1/8"	10	6	150
T6 BU 200	T6 NBU 200	1/8"	10	6	200
T6 BU 250	T6 NBU 250	1/8"	14	6	250
T9 BU 50	T9 NBU 50	1/4"	14	9	50
T9 BU 100	T9 NBU 100	1/4"	14	9	100
T9 BU 150	T9 NBU 150	1/4"	14	9	150
T9 BU 200	T9 NBU 200	1/4"	14	9	200
T9 BU 250	T9 NBU 250	1/4"	14	9	250
T12 BU 100	T12 NBU 100	3/8"	17	13	100
T12 BU 150	T12 NBU 150	3/8"	17	13	150
T12 BU 200	T12 NBU 200	3/8"	17	13	200
T12 BU 250	T12 NBU 250	3/8"	17	13	250
T16 BU 100	T16 NBU 100	1/2"	22	16	100
T16 BU 150	T16 NBU 150	1/2"	22	16	150
T16 BU 200	T16 NBU 200	1/2"	22	16	200
T16 BU 250	T16 NBU 250	1/2"	22	16	250

Spare seal / Ersatz O-Ring (NBR +100°C)

Order No Bestell Nr.	Serie	Temperature
	CG T6 N	N 6
	CG T9 N	N 9
	CG T16 N	N 16
		-10° / 100° C
		-4° F / +212° F

Spare seal / Ersatz O-Ring (Viton V)

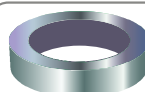
Order No Bestell Nr.	Serie	Temperature
	CG T6 V	N 6
	CG T9 V	N 9
	CG T16 V	N 16
		-20° / 200° C
		+14° F / +392° F